

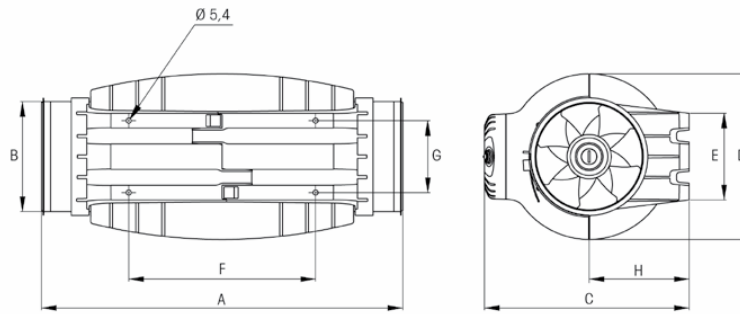

6393 Powers Avenue
 Jacksonville, Florida 32217-2298
 P: 800.961.7370 F: 800.961.7379
 www.solerpalau-usa.com

MODEL TD-SILENT

(Extremely quiet for High Air Flow to Pressure Ratio Applications Minimum Space)



Dimensions inches/mm

Model	A	B Ø	C	D Ø	E	F	G	H
TD-125XS	22 5/8	4 5/6	9 15/16	8 1/16	3 15/16	9 13/16	3 1/4	4 3/4
TD-150S	19 1/16	5 13/16	10 13/16	8 11/16	4 9/16	9 13/16	3 3/4	5 1/4
TD-200S	22 3/8	7 13/16	12 7/8	10 3/8	5 11/16	13 3/8	5 1/16	6 7/16



FAN DATA					
Fan No.	Qty.	Model No.	CFM	SP	RPM

For more information contact us at www.solerpalau-usa.com or 1.800.961.7370 for additional submittal drawings.

Soler & Palau will not be responsible for fabrication changes or errors resulting from customer use of a non-current submittal drawing.

MOTOR DATA					
AMPS	RPM	VOLTS	PH	HZ	ENCLOSURE

ACCESSORIES	1	2	3	4	5	REMARKS

PROJECT: _____ CONTRACTOR: _____
 LOCATION: _____ REVISION DATE: _____
 FORM NO.: _____ SUBMITTED BY: _____ DATE: _____
 ENGINEER: _____ APPROVED BY: _____ DATE: _____

