

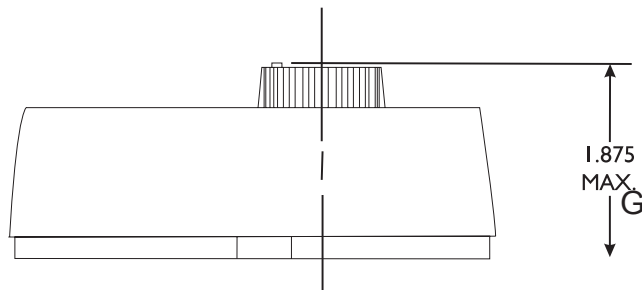

P: 800.961.7370  
www.solerpalau-usa.com

# SHW-20 - Wall Mounted Humidstat

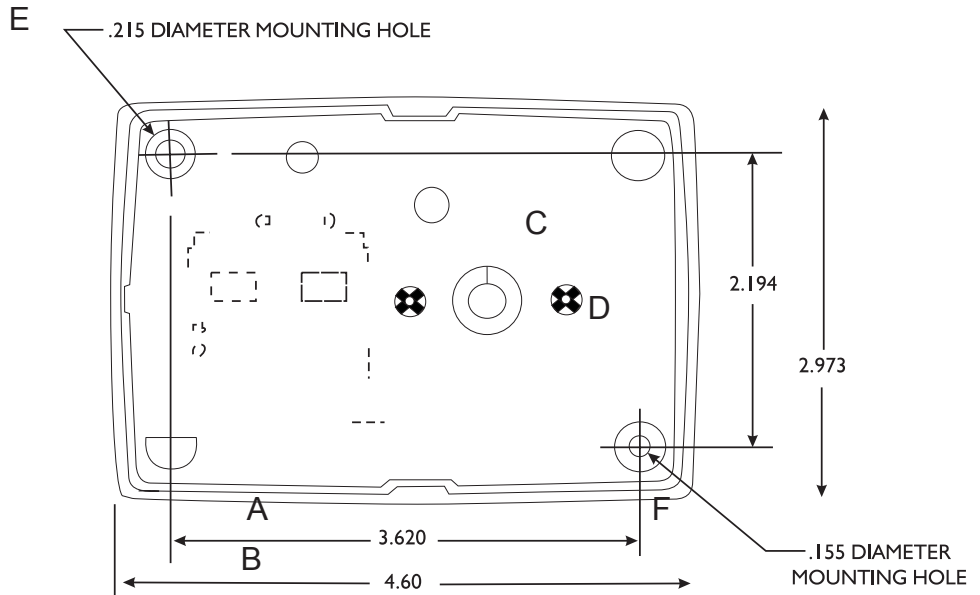

| ACCESSORY MODEL | 1 | 2 | 3 | 4 | 5 | REMARKS |
|-----------------|---|---|---|---|---|---------|
|                 |   |   |   |   |   |         |
|                 |   |   |   |   |   |         |
|                 |   |   |   |   |   |         |

|                 |                  |
|-----------------|------------------|
| Project: _____  | Submitted: _____ |
| Customer: _____ | Approved: _____  |
| Location: _____ |                  |

For more information contact us at [www.solerpalau-usa.com](http://www.solerpalau-usa.com) or 1.800.961.7370 for additional submittal drawings.

Soler & Palau will not be responsible for fabrication changes or errors resulting from customer use of a non-current submittal drawing.

